

# RBTS' 25<sup>th</sup> Annual Seminar

May 7-10, 2018, PENN STATE Great Valley, Malvern, Pennsylvania, USA

## 25<sup>th</sup> Annual Seminar & Short Course On ROTOR DYNAMICS & BEARINGS TECHNOLOGIES *Lateral & Torsional Vibration Analysis / Fluid-Film Bearings*

A 4-day seminar and workshop for engineers and technical managers involved in **ROTATING MACHINERY** design, operation, maintenance, diagnosis, and troubleshooting. The seminar focus is on machinery **rotor dynamics**, drive train **torsional vibrations**, as well as the **bearing systems** (fluid-film & rolling-element) that support, guide, and locate the rotating assembly. Detailed coverage of the field of fluid-film bearings and rotor dynamics includes the presentation of case histories and the application of advanced software for modeling, analyses, and troubleshooting real life bearing systems and vibration problems encountered in rotating equipment. No previous experience is required.

### Flexible registration for any number of days

**Day 1:**            **May 7, 2018**            Seminar "**FLUID-FILM BEARINGS**"

**Day 2 & 3:**      **May 8-9, 2018**      Seminar "**ROTOR DYNAMICS & TORSIONAL VIBRATION**"

**Day 4:**            **Workshop**            **Advanced Rotating Machinery Dynamics "ARMD™"** software demonstration, May 10, 2018      training and application to bearings, bearing systems, rotor dynamics and torsional vibration modeling, analyses and interpretation of generated results.

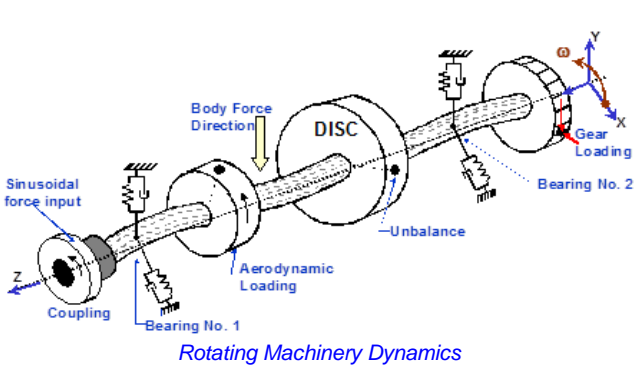

Journal/Thrust Bearings



Spherical Roller Bearing

*Prepared & Presented by:*



**RBTS, Inc.**

**Rotor Bearing Technology & Software, Inc.**

1041 West Bridge Street, Phoenixville, Pennsylvania 19460, USA

◆ Tel: 610-415-0412

◆ email: [seminars@rbts.com](mailto:seminars@rbts.com)

◆ Fax: 610-415-0413

◆ web site: [www.rbts.com](http://www.rbts.com)

Seminar certificates will be issued and can be used for PE training requirements

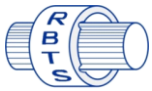

## About The Course

This course is designed for engineers and technical managers who are involved in [rotating machinery design, operation, maintenance, diagnostics](#), and [troubleshooting](#), with emphasis on bearings and bearings systems, machinery [rotor dynamics](#), and drive train [torsional vibration](#).

The first half of the course will focus on bearings, the vital tribological element of rotating machinery, beginning with their fundamental principles of operation through computer-implemented evaluations of their operational performance characteristics and limitations. Design considerations and applications of fluid-film bearings will be discussed along with the presentation of numerous real life case histories to illustrate the technology and its application to rotating machinery failure analysis and troubleshooting of common, as well as, unique vibration problems. Following the fluid-film bearings, an introduction to rolling element bearings will be presented illustrating their various applications and their effects on system rotor dynamic .

The second half focuses on rotating machinery dynamics ([rotor dynamics & torsional vibration](#)). The interacting influence of bearings on the dynamic behavior of machinery will be reviewed and illustrated by the construction of analytical models, and evaluated by computerized solutions. Participants are encouraged to present problems to be discussed. Informal technical sessions and workshops are intended to provide participants with adequate time to describe problems they have encountered in bearings, bearing systems, rotor dynamics and torsional vibration.

ARMD™ software will be available at the seminar and workshop for problem solving, and for the application of [state-of-the-art computer-aided engineering of bearings and rotor dynamics](#). Participants will have access to RBTS' popular Advanced Rotating Machinery Dynamics software package ARMD™.

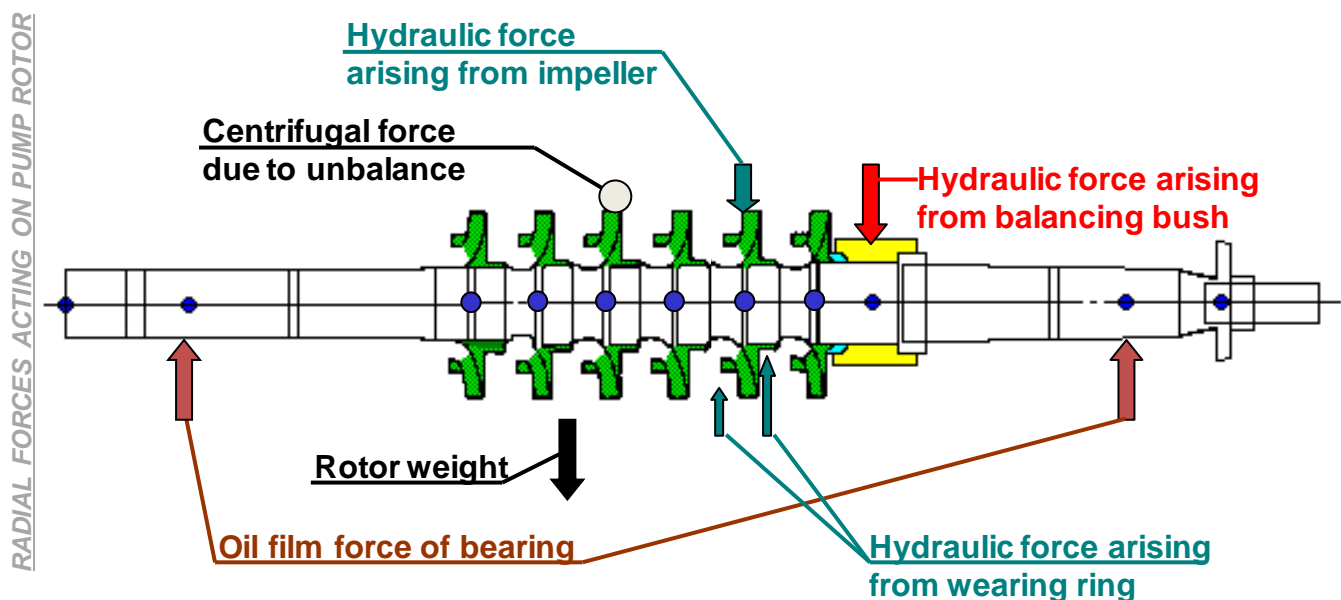

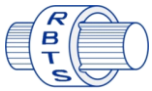

# RBTS' 25<sup>th</sup> Annual Seminar

## Day 1 – Fluid-Film BEARINGS

This session is presented in a simple way to understand the technology of sliding surface bearings so that participants with or without previous knowledge benefit from the presentation and can apply it immediately in their profession. The session is a full coverage of fluid-film BEARINGS (the vital tribological elements of rotating machinery that support, guide, and locate the rotating assembly) beginning with their fundamental principles of operation through computer-implemented evaluations of their operational performance characteristics and limitations. Design considerations and applications of sliding surface bearings with emphasis on HYDRODYNAMICALLY lubricated fluid-film bearings will be discussed along with presentations of practical examples and case histories. Topics include:

### INTRODUCTION TO BEARINGS (Includes the presentation of a real life bearing failure problem and effective solution taking time and cost in to consideration)

- Functional Roll
- The Two Primary Classes
- Noteworthy Differences Between The Two Classes Of Bearings

### SLIDING SURFACE BEARINGS

- Fundamentals
- Distribution of Bearings Hardware/Demonstration
- Types and Definition
- Load Support Mechanisms
- Modes of Lubrication
- Frictional Response Characteristics
- Lubricant Temperature/Viscosity Dependent Properties and Heat Balance Effects
- Terms and Concepts of Hydrodynamic Lubrication and Its Requirements
- Terms and Concepts of Hydrostatic-Hybrid Lubrication and Its Requirements
- Turbomachinery Hydrodynamic Bearing Types, Performance, and Dynamic Characteristics
- Oil Whirl / Whip
- Advantages / Disadvantages
- Cost



### FLUID-FILM BEARING TYPES AND APPLICATIONS

- Fixed & Tilting Pad Geometries
- Journal, Thrust & Conical

### BEARINGS STATE-OF-THE-ART TECHNOLOGY

- Advanced technology presentation & demonstration
- Summary of course content and application of bearings technologies

### WORKSHOP

- Participants' systems
- Group discussion

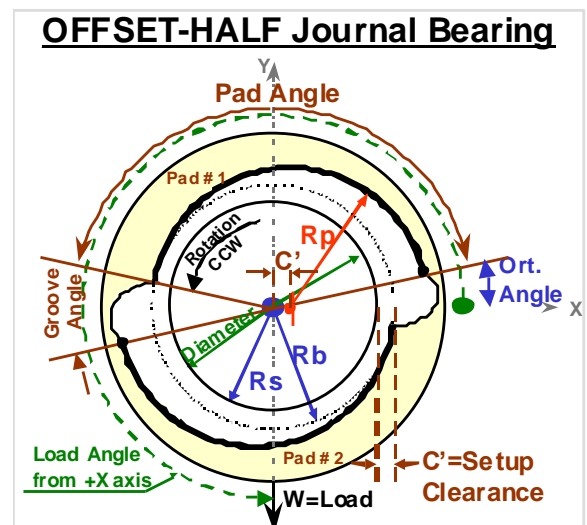

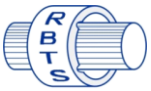

# RBTS' 25<sup>th</sup> Annual Seminar

## Day 2 & 3

# Rotor Dynamics & Torsional Vibration

Rotor dynamics and torsional vibration technologies presented in a simple way to participants, with or without previous knowledge, to be applied immediately in their profession. Commonly used terminology in the industry such as lateral and torsional **critical speeds**, **mode shapes** (rigid body & bending), **stability**, bearing **whirl/whip**, phase angle, critical damping, **gyroscopic** effects, **unbalance**, **API-amplification factors** & required **separation margins**, etc., will be discussed and illustrated throughout the course by the presentation of practical examples and case histories. The course handout includes sufficient details to be used as a reference including a tutorial section on rotor dynamic fundamentals and terminology. Topics include:

**INTRODUCTION & OVERVIEW** (Includes the presentation of a real life vibration problem and cost/time effective corrective actions taken as a solution)

### BASICS OF MACHINERY VIBRATION – Introduction

- Vibration Theory – Single mass system, planar vibration.
- Response & Shaft Dynamics – Displacement, velocity & acceleration amplitude & phase.
- Forces in Rotating Equipment – Bearings, Cavitation, Imbalance, Hydraulic, Aerodynamic.

### ROTOR DYNAMICS & TORSIONAL VIBRATION – Basics

- Introduction & Application.
- Parameters of Interests.
- Vibration Analysis Types - Lateral, Torsional, & Axial.
- Stability & Response.

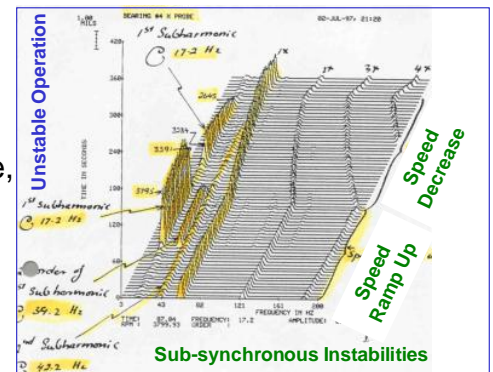

### ROTOR DYNAMICS – THEORY

- Rigid Rotor – One degree of freedom free & forced vibration.
- Simplified Rotor System Behavior – Dynamic vectors (displacement & force), critical speed, phase angle, stability parameter and the effects of system mass, stiffness, and damping.
- Flexible Rotor – Multi degree-of-freedom system.

### ROTOR DYNAMICS – Advanced

- Synchronous Steady-State Response.
- Non-Synchronous Time-Transient Response.
- Balancing Grades & Guidelines.
- API Standards & Guidelines - Amplification Factor, Critical Response Envelope. Required Separation Margins for Operation Below & Above Critical Speed, Shaft Vibration Orbit properties.

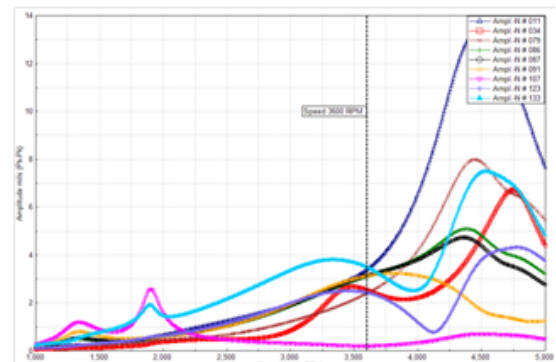



## REQUIREMENTS FOR ROTOR DYNAMIC ANALYSES

### Modeling

- Shafting.
- Disks – Impellers, Couplings, Thrust Collars, Blades, Balanced pistons, etc.
- Bearings – Fluid-Film & Rolling Element
- Seals – Wear-rings, Labyrinth.
- Housing/Pedestal.
- Aerodynamic, Steam Whirl, Hydraulic Effects.
- External Excitations.
- Gyroscopic Effects.

### Analysis

Damped & Undamped Rotor Stability, Natural Frequencies, Mode Shapes, Stability & Critical Speed Maps, and Response.

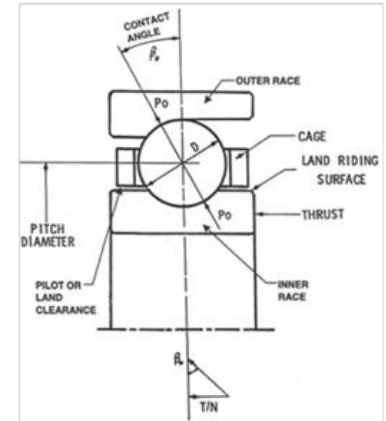

## ROTOR DYNAMICS DETAILED CASE HISTORY

- **Step-by-Step Rotor-Bearing System Modeling**, Analysis, and Problem Solution by the Introduction of Rotor Dynamics Software and its Application to a Rotor-Bearing System.
- **Bearing Interaction** with the Rotating Assembly, Oil-Whirl/Whip Phenomena, Rotor-Bearing Response, and Stability Illustrations.

## TORSIONAL VIBRATION – Advanced

- Modeling Considerations – Shaft, Inertia, Coupling, Bearings, Damping, etc.
- Analysis Types & Generated Results Interpretation.

## TORSIONAL VIBRATION DETAILED CASE HISTORIES

- Simple Two-Disc System.
- Direct Drive Fixed Speed – 75kw Electric motor driven 4 stage gas booster centrifugal compressor.
- Synchronous Motor–Gearbox–Compressor Drive Train Start-Up Simulation.
- Failure Analysis of 2000hp Electric Motor Driving a 4-Throw Reciprocating Compressor and Cost Effective Solution.

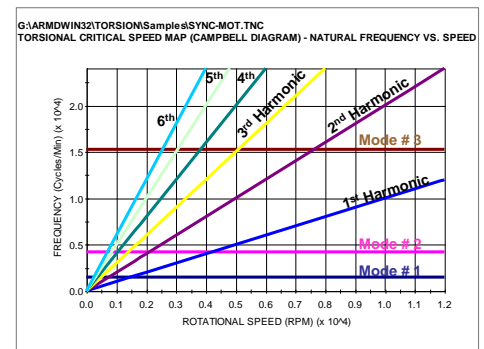

## STATE-OF-THE-ART TECHNOLOGY PRESENTATION & DEMONSTRATION

- Advanced Technology Presentation & Demonstration
- Summary of Course Content and Application of Rotating Machinery Dynamics Technologies

## WORKSHOP

- Participants' Systems
- Group Discussion

During the session, numerous real life case histories will be presented to illustrate the technology and its application to rotating machinery failure analysis and troubleshooting of common, as well as unique vibration problems.

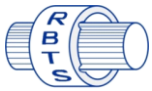

# RBTS' 25<sup>th</sup> Annual Seminar

## Day 4 – ARMD Users Workshop Rotor Dynamics & Bearings Software Application

This workshop is planned for users/participants who are interested in the detailed modeling and analysis of bearings and rotor/bearing systems utilizing the **ARMD™ Software**. Participants can bring their own **rotating machinery** and **bearings** problems to be presented and discussed in an open session, watch a problem developed and solved, or use the software and create their own models and perform the analysis of their interest. Time will be allocated to discuss FAQs and some details of the ARMD software, which has been used to solve the seminar and end-user sample problems. The workshop will mainly cover the following subjects:

### MODEL GENERATION

- Introduction & Problem Description
- Getting the "Right" Parameters
- Dividing the Rotating Machine Into Components for Modelling And Integration
- Verification of Constructed Model

### ROTOR/BEARING SIMULATION

- Deflection & Load Calculations
- Bearing Performance and the Generation of Dynamic Coefficients (Stiffness and Damping)
- System Natural Frequency, Mode Shapes and Stability Calculations
- Critical Speed Map Generation
- Stability Map (CAMPBELL Diagram)
- Synchronous Unbalance Response
- Non-Synchronous Time Transient Response

### INTERPRETATION OF RESULTS

- Acceptable Bearing Performance
- Rotating Machinery Dynamic Performance and Cost Effective Corrective Action
- Comparison/Correlation of Calculated & Measured Machinery Dynamic Performance

### APPLICATIONS

- Participants' Problems (if available and can be shared)
- Group/Instructor Sample Problem
  - Fixed & Tilting-pad fluid-film journal/thrust bearings.
  - Lateral/Torsional rotor dynamics.

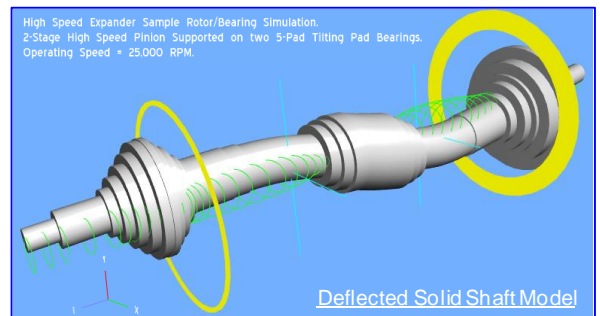
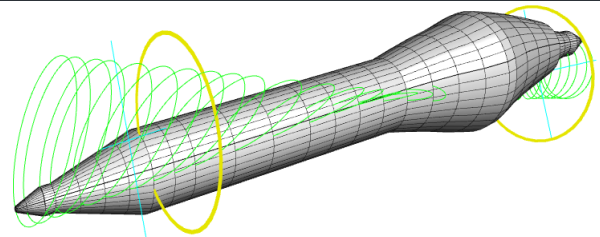
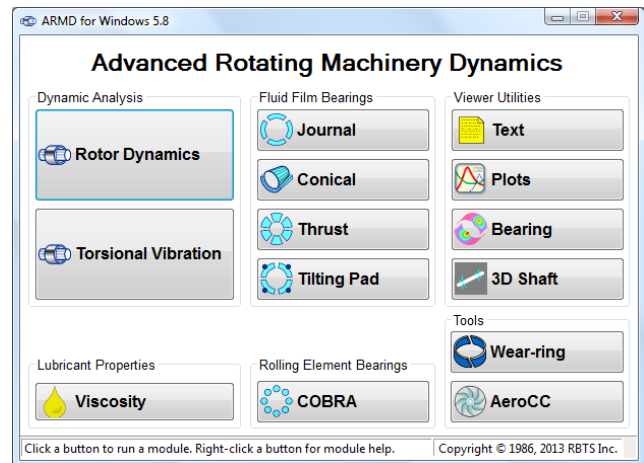

ARMD User  
RBTS, Inc.

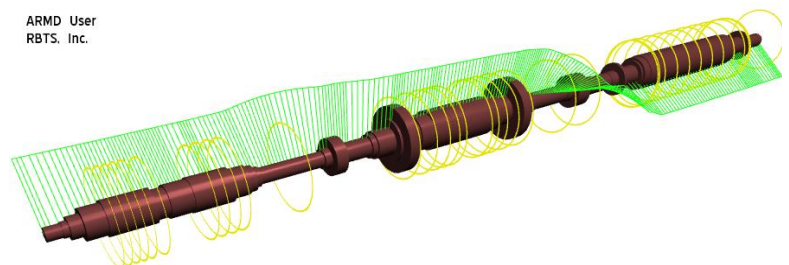

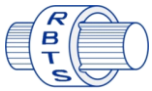

# RBTS' 25<sup>th</sup> Annual Seminar

## Registration Form

Please fill in this form and fax or email it back to RBTS

The course will be held at **PENN STATE Great Valley** in the **Main Building**, 30 E. Swedesford Road, Malvern, Pennsylvania, USA. Detailed information, directions, and area hotels can be found on the PENN STATE web site at <http://www.sgps.psu.edu/conferences>.

Attendance is limited. Reservations will be accepted on a first-come, first-served basis and will be confirmed following receipt of registration fee payment or acceptable purchase order.

For additional information, or questions, please contact **RBTS** at:

Tel: 610-415-0412	Fax: 610-415-0413	email: seminars@rbts.com
-------------------	-------------------	--------------------------

<b>Sign me up for the following days</b> <i>(Please check applicable boxes for registration)</i>		<u>Fee Schedule</u>
<input type="checkbox"/> <b>Day 1</b> May 7, 2018	Seminar: <b>FLUID-FILM BEARINGS</b>	<b>1 day = \$795</b>
<input type="checkbox"/> <b>Day 2 &amp; 3</b> May 8-9, 2018	Seminar: <b>ROTOR DYNAMICS &amp; TORSIONAL VIBRATION</b>	<b>2 days = \$1495</b>
<input type="checkbox"/> <b>Day 4</b> May 10, 2018	Workshop: <b>ARMD</b> software training	<b>3 days = \$2095</b>
		<b>4 days = \$2295</b>
<b>Last Name:</b>		
<b>First Name:</b>		
<b>Title/Department:</b>		
<b>Company Name:</b>		
<b>Street Address:</b>		
<b>City, State, Zip:</b>		
<b>Country:</b>		
<b>Telephone:</b>		
<b>Fax:</b>		
<b>Email Address:</b>		
<b>I will bring my own PC</b>	If you bring your own PC, you can install and use ARMD™ software anytime during the 4 day seminar. <input type="checkbox"/> Yes <input type="checkbox"/> No	
<b>Payment Method:</b>	<input type="checkbox"/> Check Enclosed Amount: _____	<input type="checkbox"/> Company PO No. _____
	<input type="checkbox"/> INVOICE me for payment	<input type="checkbox"/> Credit Card Send me form

Return form to: **Rotor Bearing Technology & Software, Inc.** ◆ Tel: 610-415-0412  
 1041 West Bridge Street ◆ Fax: 610-415-0413  
 Phoenixville, Pennsylvania 19460, USA ◆ email: seminars@rbts.com

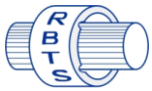

# RBTS' 25<sup>th</sup> Annual Seminar

## Accommodations

PENN STATE Great Valley is 45 minute drive from Philadelphia (PHL) International airport.

It is suggested that attendees make their own hotel reservation at the following hotel (indicate that they will be attending RBTS course at **PENN STATE** Great Valley):

### Homewood Suites Hotel, Philadelphia/Great Valley

12 E. Swedesford Road, Malvern, PA 19355

Phone: 610-296-3500

Fax: 610-296-1941

(adjacent to PSGV, 2 minute walk to class, **Ask for PSU rate**)

Room rate: **\$149** reflecting PSU rate. Rate includes buffet style hot/cold breakfast and dinner.

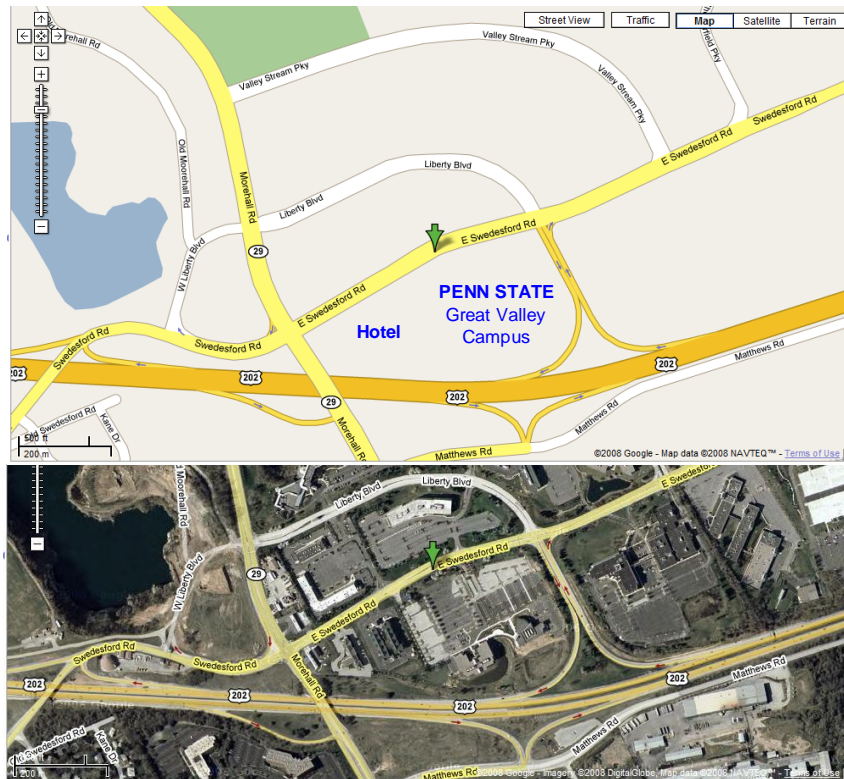

There are numerous hotels in the Malvern, Valley Forge, King of Prussia areas and within a short driving distance from the PENN STATE Great Valley. Feel free to find your own, or contact RBTS for extended listing. Alternatively, visit PENN STATE web site at "<http://www.sgps.psu.edu/conference>", there you can find **Directions & Parking** for maps, directions, hotels, etc., and to learn more about the many things you can do visiting the area.



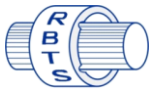

# RBTS' 25<sup>th</sup> Annual Seminar

---

## Speakers

◆ **VICTOR K. OBEID** has over 30 years of experience in the fields of rotor dynamics, fluid-film and rolling-element bearings, machinery vibration, failure analysis and troubleshooting. He is a pioneer in the development and application of PC based state-of-the-art computer aided design software for predicting the dynamics of complex rotor-bearing systems. A former Staff Engineer at the Franklin Institute Research Laboratories and a technical leader at RBTS, he directs government and industry sponsored projects involving design, analysis and trouble-shooting of rotating machinery systems and their components. He has been instrumental teaching and training in the fields of bearings and rotor dynamics, and their application to common as well as unique equipment design, operation, and failure analysis. He taught seminars and training sessions worldwide at rotating equipment OEM, end users, packagers, government agencies, and open seminars to machinery engineers. Mr. Obeid holds a Bachelor degree from Drexel University and Master of Science degree from Penn State University, both in Mechanical Engineering.

◆ **CHARLES W. YEISER** has over 25 years experience in the technical evaluation of structural and rotating machinery dynamics that encompasses application, design, software development, systems evaluation, failure analysis and trouble-shooting. He has extensive experience in developing linear and non-linear finite element and specialized fluid-film/rolling-element bearing applications, which included structural deformation and heat transfer. For the past 10 years he has developed and successfully applied advanced computational techniques to evaluate torsional vibrations in hundreds of mechanical drive systems. Mr. Yeiser holds a Bachelor of Arts in Physics from Franklin & Marshall College, as well as Bachelor and Master of Science degrees in Engineering from the University of Pennsylvania.

*For additional information, or questions, please contact **RBTS** at:*

Tel: 610-415-0412

Fax: 610-415-0413

email: [seminars@rbts.com](mailto:seminars@rbts.com)